

Greenhouse, poly-tunnel and

Protection systems

What's new...

Gripple

A comprehensive range of wire joining and tensioning products for use in fencing and trellising, and for hanging and support systems in greenhouses and poly-tunnels

Gripple Torq Tensioning Tool

The new improved Gripple Torq Tensioning Tool not only tensions wire but regulates the load applied too, delivering consistent results every time and maximising the life of the wire.

Gripple T-Clip

The new Gripple T-Clip is a revolutionary new way to terminate a fence. This new product eliminates timely knotting and stapling wires at end posts with one fast, simple 'twist push' action.

Gripple Universal Anchor

The new Universal Gripple Plus Anchor Kits are ideal for use in vineyards or orchards. Use on wood, metal or concrete posts to brace end posts to ground anchors.



Gripple Range - fence, trellis, anchoring, greenhouse & poly-tunnel

Gripple	Type	Wire Size	Max. Load	Gripple Hangers	Size	Max. Load (5:1 safety factor)
Gripple Joiners & Tensioners	GP1 (single channel)	1.80 - 3.00 mm	400 kg / 880 lb	Gripple Hangers for Greenhouses and poly-tunnel applications <i>(Available with various end fixings)</i>	No.1	10 kg / 22 lb
	GP Small	1.40 - 2.20 mm	300 kg / 660 lb		No.2	45 kg / 100 lb
	GP Medium	2.00 - 3.20 mm	400 kg / 880 lb		No.3	90 kg / 200 lb
	GP Large	3.25 - 4.20 mm	600 kg / 1320 lb		No.4	225 kg / 495 lb
	Gripple Jumbo	2.50 - 3.10 mm	600 kg / 1320 lb		No.5	325 kg / 715 lb
	Gripple Barbed	2 x 2.5 mm barbed	150 kg / 330 lb		- / -	
GPAK	GPAK 3	3.0 mm x 4.5 m	400 kg / 880 lb			
	GPAK 4	4.0 mm x 5.0 m	600 kg / 1320 lb			
Lockable Kit	LOCK 5	4.75 mm x 4.0 m	1200 kg			
	LOCK 6	6.35 mm x 6.0 m	2400 kg			

Product Range

With the trend in consumer demand and the change in global climate, greenhouses and poly-tunnels are now being used more and more within the horticultural industry. The cultivation and protection properties offered by these structures allow fruits, vegetables and flowers to be grown all-year-round in almost any region of the world.

There are many uses for Gripple within this market area. The traditional Gripple wire joiners and tensioners can be used for plant support and trellising but in addition, there are a range of Gripple solutions for structural support and for installing equipment, essential for atmospheric control.

Gripple Hanger Kits
Gripple Hanger Kits are for suspending static equipment, for example lights and heaters, and have been designed with a 5:1 safety factor for use in safety critical overhead applications.

Gripple Plus Anchor Kits (GPAK)
Gripple Plus Anchor Kits are for bracing, anchoring and securing structures.

Gripple Plus Units
Gripple Plus units come in a variety of sizes and are for joining and tensioning wire or monofilament – for example, support wires.

Lockable Gripple Kits
The same principal as all other Gripple units but the Lockable Gripple Kit comes complete with locking screws giving additional security in dynamic installations.

- Cross bracing structures
- Overhead bracing
- Anchoring
- Shade cloth and thermal screen
- Irrigation support
- Hanging systems for lighting
- Hanging systems for heating
- Cooling and climate control



Gripple Ltd.
The Old West Gun Works
Savile Street East
Sheffield
S4 7UQ
Tel: +44 (0)114 275 2255
Fax: +44 (0)114 275 1155
Email: info@gripple.com

Gripple Inc
1510 Hubbard Avenue
Batavia
Illinois 60510
USA
Tel: +1 630 406 0600
Fax: +1 630 406 0664
Email: info@gripple.com

Gripple S.à.r.l
1, Rue du commerce
BP 37
F 67211 Obernai
France
Tel: +33 (0)3 88 95 44 95
Fax: +33 (0)3 88 95 08 78
Email: info@gripple.com



Gripple Plus Fencing

New Gripple **TORQ** Tensioning Tool

Gripple Plus Trellising



...know your limits



Using Gripple significantly reduces the amount of time and labour needed to install and maintain your fence.



Unlike using knots and crimps, Gripple allows you not only to join wire, but to **tension wire too**. Each Gripple is fitted with a ceramic roller mechanism that allows movement in one direction only, resulting in the ability to always tension the wire. The high performance, engineering grade ceramics, not only provide a secure grip on all types of wire, but also have excellent corrosion resistance to sprays and fertilisers.

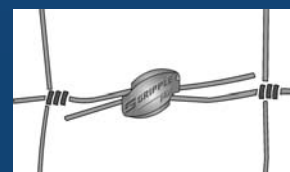

In addition to using gripple to join plain wire, barbed wire, electric fence and stock netting, the Gripple system can also be used to brace fence posts too. Gripple 'GPAKs' come complete with a Gripple unit and a length of wire rope with a pre-ferruled loop at one end, for fast and easy installation. The kit can be installed and tensioned in less than 1 minute.

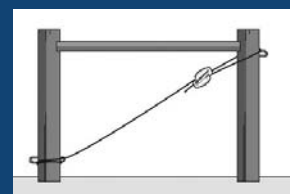
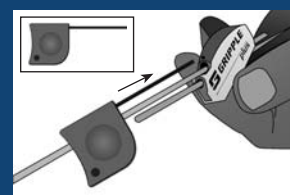
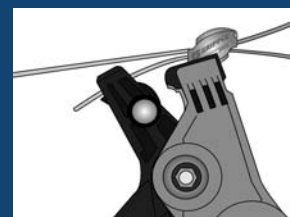
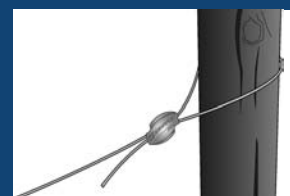

Gripple T-Clip

The new Gripple T-Clip is a revolutionary new way to secure a fence at the start or at the end. This new product eliminates timely knotting and stapling wires at straining posts with one fast, simple, 'twist & push' action.

Simply twist and hook the Gripple T-Clip onto each line wire, wrap the line wire around the straining post and back into the Gripple T-Clip.

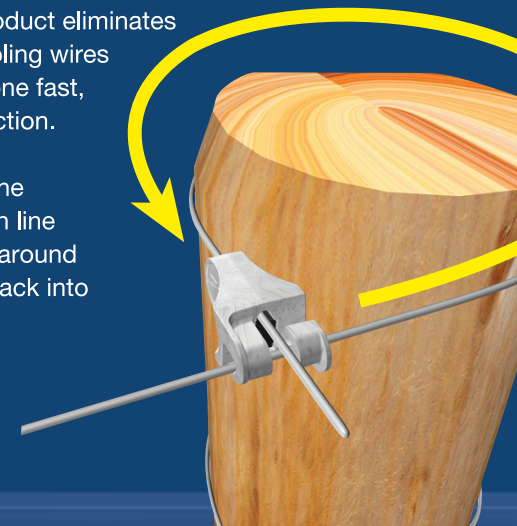

- Now with new settable tension gauge
- Measure from 50kg to 400kg
- Just 'set & go' - consistent tension every time
- Deliver up to 400kg of tension with minimum effort
- Designed for use on all Gripple Plus products
- New robust design

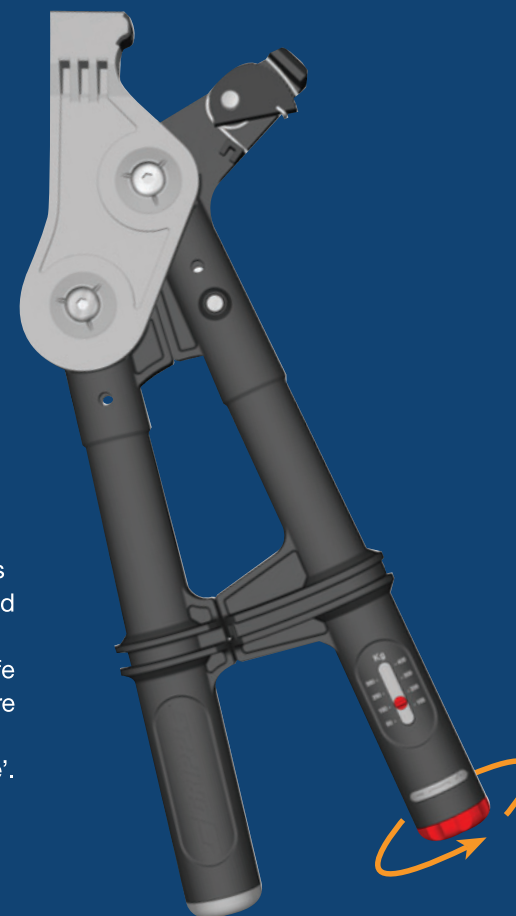

The new improved Gripple Torq Tensioning Tool not only tensions wire but regulates the load applied too, delivering consistent results every time and maximising the life of the wire. This integrated feature is a huge step forward in both fencing and trellising 'best practice'.



1. To set the required tension, twist the grip until the gauge reads the required load.
2. As normal, position the Gripple unit in the mouthpiece and grip the tail wire with the tool cam.
3. Squeeze the handles together until the desired tension is reached.
4. When the desired tension is reached, this is signalled to the operator by a 'click' and slight movement in the handle.



Millions of Gripples have been used in fruit and wine growing for over twenty years. Using Gripple to join and tension the wire trellis and for anchoring the structure itself, provides a solid foundation for growing healthy plants, delivering healthy crops year-after-year.

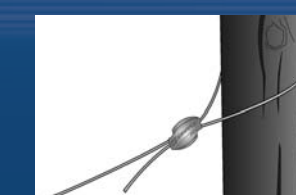

There are a range of Gripple products to suit the wire diameter and load required. All are fitted with ceramic rollers for ultimate grip on to hard wire and for optimum corrosion resistance. At installation, the trellis wires can be tensioned with the Gripple Tensioning Tool and after harvesting, when the crop weight has been removed from the wires, simply use the Gripple Tensioning Tool again to tension the wires ready for the next season's growth.

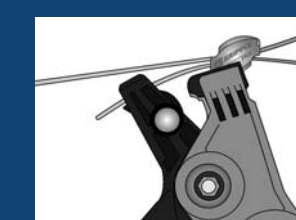

Secure anchoring for the end posts is essential too. Use the Gripple GPAK kits to brace the trellis structure securely to the ground. Again, different products are available to suit the size and type of installation eg. Grapes, Kiwi fruit, Hops, soft fruits and berries, olives etc.

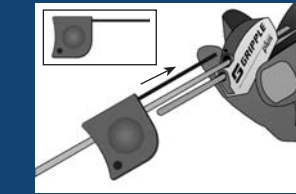

Gripple Universal Anchor Kit

The new Universal Gripple Plus Anchor Kits (GPAK) are ideal for bracing end posts to anchor points in vineyards and orchards.

- Versatile end fixing allows for looping around wooden posts or through metal post holes
- Heavy galvanised wire rope for optimum corrosion resistance
- Double brace format for maximum load distribution
- Re-tension year-on-year

